

contacta 

Under the Counter Loop System IL-K200

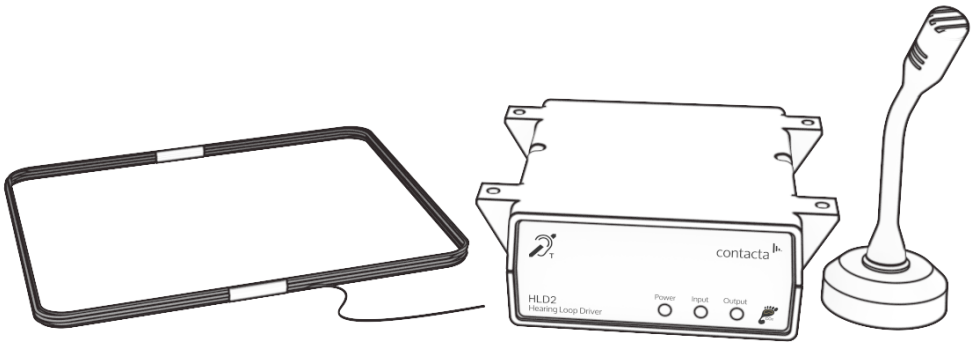

Installation & User Guide

January 2018

Contents

Product Overview	4
Components	4
Recommended Tools	4
Installation Instructions	5-6
Initial Set-Up	7
The Loop Driver	7
Handy Tips	8
Using the System	9
Maintenance	10
Troubleshooting	11

Product Overview

Our Under the Counter loop system provides clear communication with hearing device wearers, especially where background noise is a problem or clear speech is restricted.

It has a flexible aerial that can be bent to shape, allowing it to be installed into many different positions under a desk or counter unit.

Components

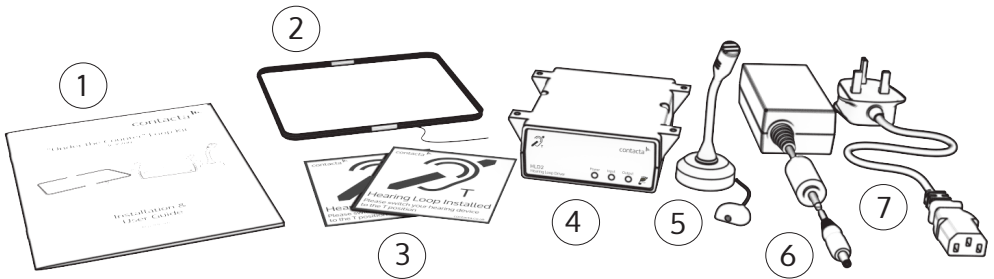

1. Installation and User Guide
2. Hearing Loop Aerial
3. Hearing Loop Stickers x 2
4. HLD2 Loop Driver
5. Noise-cancelling Microphone **or** Mouse Microphone
6. Power Supply
7. IEC Lead

Recommended Tools

- Cable tacker
- 2.5mm flat head screwdriver
- Phillips PH2 screwdriver (or equivalent)
- Wire cutters/strippers
- Battery drill
- Assorted drill bits
- Zip ties
- Electrical insulation tape
- Hearing loop listener

Installation Instructions

We recommend that installation is carried out by a qualified engineer, adhering to the relevant standards.

1. Check the contents of the box to familiarise yourself with the components.
2. Ascertain the best locations for the various components, such as where the driver will be attached.
3. Position the aerial under the counter using either our P-clips, or another suitable fixing method of your choice. See the diagram below for recommended positioning.

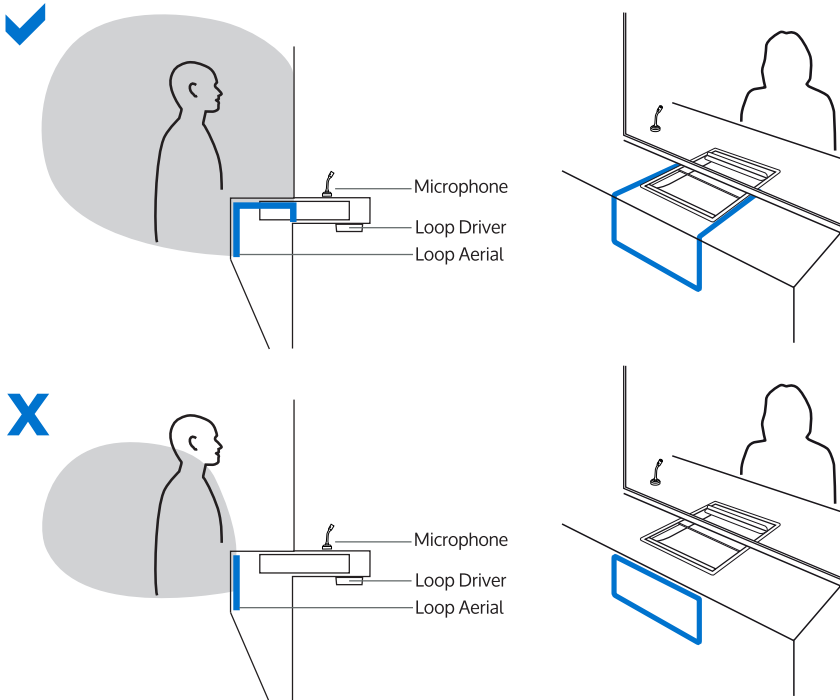

4. Place the microphone as close to the staff member as possible, without causing an obstruction, and fix to the counter using the double-sided pad.

5. Check the cable route to the driver location, especially cable length to other components and access through the counter top.
6. Place the driver in the correct location under the staff counter.
5. Mark the 4 fixing points for drilling.
6. Drill and fix the driver in place using the screws provided.
7. Install the power supply close to a power socket outlet using the supplied mounting bracket and fixing screws.

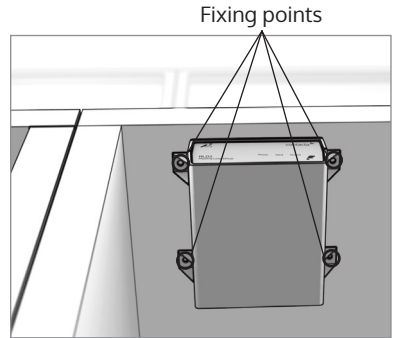

8. Connect all components together by following the below:

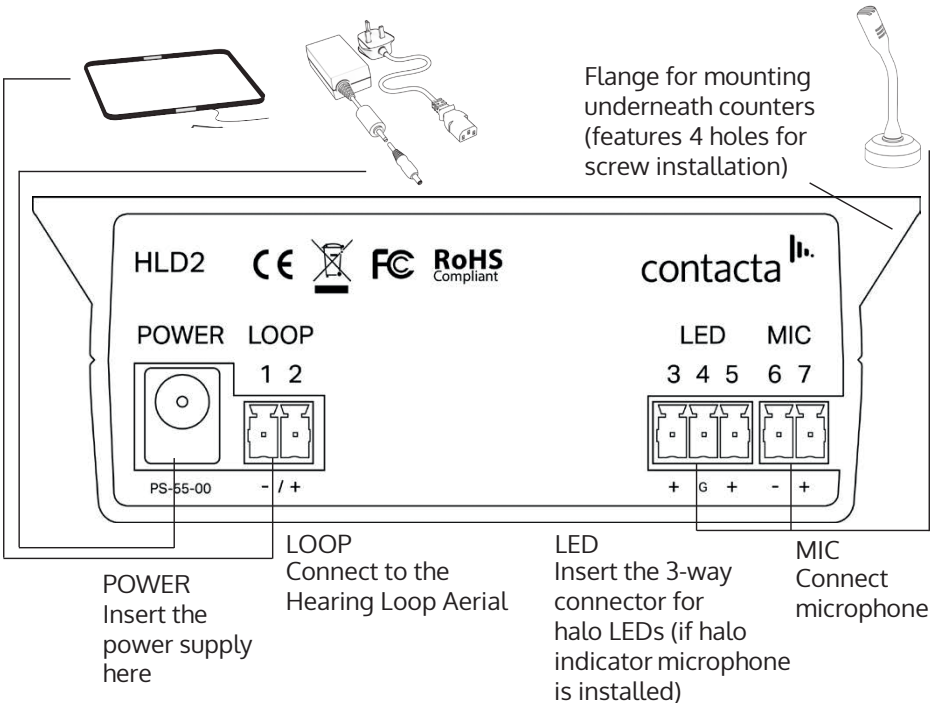

9. Route all the cables neatly to the driver using trunking or cable tacking as necessary.

Initial Set-Up

Once installed, volume adjustments are not needed as the driver self-adjusts; the system is ready to operate. Please ensure you test the loop using one of our loop listeners.

The Loop Driver

The driver has no buttons on the front panel. Please see below an overview of the indicators on the front panel of the HLD2 driver.

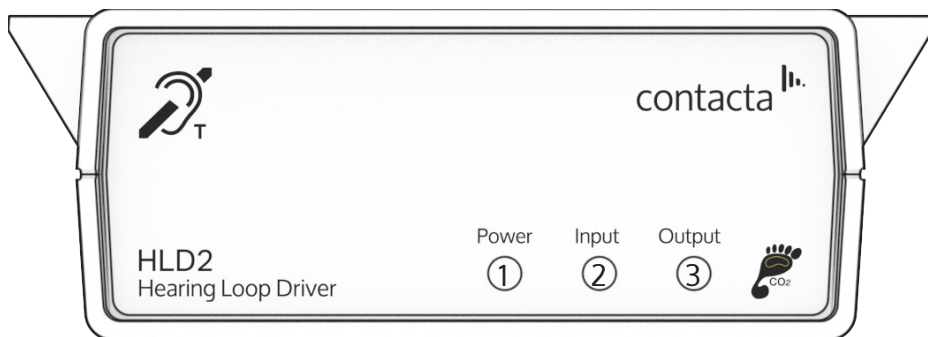

1. Power LED:

Solid green when correctly powered.

Flashes green once every 25 seconds when in "Power Save" Mode.

Solid red when incorrect power supply connected.

2. Input LED:

Flashes green when microphone is operating correctly.

Solid red if microphone is faulty or no input detected.

3. Output LED:

Flashes green when loop output is functioning correctly.

Solid red when aerial is faulty/disconnected.

Handy Tips

Removing Green Connectors

Each component comes fitted with two-way and three-way connection plugs located in the appropriate sockets at the rear of the driver. If wires require to pass through small apertures, the connection plugs may be removed temporarily.

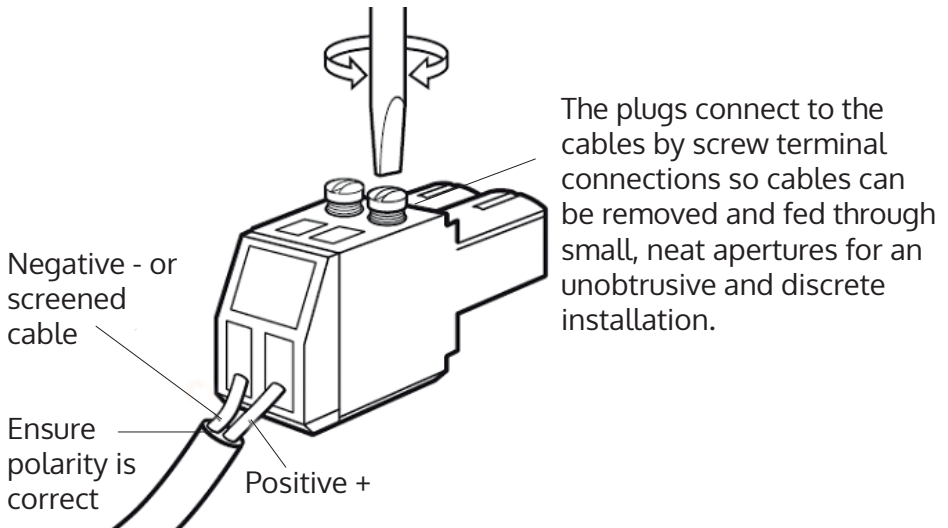

The cables and plugs must be re-connected correctly or the system will not operate. If in doubt, mark the wires before disconnecting the plug(s).

If there is a suitable cable port on the cashier's side, the cables can be diverted through this without the need to remove and reconnect the two-way plugs.

Using the System

- Face the microphone and speak normally from your seated/ standing position
- The speech is converted to an alternating magnetic field and transmitted via the loop aerial
- This is picked up by the telecoil in the customer's hearing device and converted back to speech

There's nothing more you need to do!

If the hearing device wearer doesn't pick up the signal:

- Draw their attention to the loop sign, checking their device is in the "T" position
- Ask the hearing device wearer to check the volume setting on their device
- Try moving closer to the microphone to achieve clearer voice pick-up
- Ask the hearing device wearer to move close to the loop sign

Things to Remember

- Ensure the microphone is positioned close to the member of staff on the desk or counter
- Make sure the loop sign is in a prominent position so those with a hearing device are clear as to where assistance is available

Maintenance

To prolong the life of the product, the following procedures should be carried out on a regular basis, keeping the system at its optimal performance:

- Ensure all connectors are firmly inserted into their sockets on a regular basis
- Do not stretch the microphone cable
- Clean the driver and the microphone with a dry soft cloth/ cleansing wipes. Do not use solvent based cleaners
- Do not allow cleaning fluids to enter the driver or back ports/vents of the microphone
- Regularly check that any loop listeners used to check the system are working correctly

Troubleshooting

Symptom	Possible Fault	Action
No power detected through amplifier	1) Power jack not plugged in or faulty 2) Plug fuse has blown 3) Faulty power supply unit 4) Faulty amplifier	1) Check power jack is firmly plugged in 2) Put the unit to one side and seek further advice 3) Change the power supply unit 4) Contact your local dealer
POWER LED illuminated red	1) Faulty or incorrect power supply connected	1) Ensure the correct power supply is connected (PS-55-00) 2) Contact your local dealer if not
INPUT LED illuminated red	1) Faulty or incorrectly connected microphone	1) Check microphone is wired correctly in green plug and connected to "MICROPHONE" socket on back of HLD2 driver
OUTPUT LED illuminated red	1) Faulty or incorrectly connected loop aerial	1) Check loop aerial is connected to "LOOP" socket on back of HLD2 driver
Red LED illuminated on microphone (if halo indicator microphone is installed)	1) Constant red LED: Microphone fault 2) Red LED comes on after speech: Hearing loop aerial fault	1) Ensure microphone is firmly plugged in 2) Check to make sure the hearing loop connector is firmly plugged in
No audio is heard through the hearing loop via a hearing aid or loop listener	1) Hearing loop disconnected 2) Microphone disconnected	1) Check above for correct connections 2) Ensure loop listener has a new set of batteries
Interference (buzzing/whistling/ hissing) is heard through hearing loop	1) Unscreened or poorly earthed third party equipment is being used in close proximity 2) Incorrect power supply being used	1) Switch off any third party equipment to identify the source of interference 2) Ensure that our grounded power supply unit is being used (PS-55-00)
Unit does not go into power saving mode	1) Ambient noise in area is too high	1) Switch off any air con systems, desktop fans and or computers to reduce ambient noise

If you are still experiencing problems, please contact your local dealer.



Contact your local distributor for
further information.

Hearing Loop Australia

1300 669 721

UK & ROW
+44 (0) 1732 223900
sales@contacta.co.uk

US & Canada
+1 616 392 3400
info@contactainc.com

www.contacta.co.uk